

## ***SONOREX TECHNIK***

Ultrasonic and rinsing baths for aqueous fluids



Valid for:

RM 110 UH, RM 110 U, RM 110 H, RM 110
---------------------------------------

RM 180 UH, RM 180 U, RM 180 H, RM 180
---------------------------------------

RM 210 UH, RM 210 U, RM 210 H, RM 210
---------------------------------------

#### Copyright & limit of liability

This document may not be reproduced, either in full or in extracts, without prior approval of BANDELIN electronic GmbH & Co. KG, hereinafter referred to as BANDELIN.

The German original is the binding version of this document. Any differences in the translation are not binding and have no legal effect. In case of any discrepancies between the translation and the original of this document, the original version will take precedence.

BANDELIN accepts no responsibility or liability for damages caused by improper handling or usage contrary to the intended purpose.

The documentation was prepared with great care. Liability for indirect or direct damages arising because of incomplete or erroneous information in this documentation, as well as in its delivery and usage, is excluded.

© 2017

**BANDELIN** *electronic* GmbH & Co. KG, Heinrichstrasse 3 – 4, Germany, 12207 Berlin,

Phone: +49-30-768 80 - 0, Fax: +49-30-773 46 99, [info@bandelin.com](mailto:info@bandelin.com)

# General

The equipment, the accessories and the preparations are to be used in accordance with the Instructions for Use and/or the product information.

The instructions are part of the scope of delivery and are to be stored in the vicinity of the device for later reference. This also applies if possession of the device is transferred elsewhere.









Before the device is put into operation, these Instructions for Use are to be read carefully and completely in order for the user to become familiarised with all functions.

The warnings and safety precautions (chapter 1.5) must always be heeded during use.

The manufacturer will not assume any responsibility for the device's safety or functional ability in the event of improper handling or usage contrary to the intended purpose. In the event of unauthorised alterations/modifications, both the warranty claim and the CE conformity will no longer be valid.

If service is required, please contact the specialist dealer in charge or the manufacturer.

## Symbols used:

Symbol	Significance	Explanation
	Danger	Identifies information that could signify a risk to life and limb, especially through electric shock, if not observed.
	Caution	Identifies information that is to be observed and adhered to without fail, to prevent damage to the device and danger to the user. When device parts are labelled with this symbol, reference must be made to the documentation.
	Warning	Warning of hot surface.
	Important	Identifies information that is important for execution.
	Note	Identifies information provided for explanatory purposes.
	Do not grip inside	For health reasons, touching the oscillating fluid is prohibited.
	Wear ear protectors	For health reasons, standing for long periods of time in the vicinity of the device without ear protectors is prohibited.
	Operating sequence instructions	Identifies instructions that are to be followed in the described sequence.

# Table of Contents

1	Product description .....	6
1.1	Mode of operation .....	7
1.2	Purpose .....	7
1.3	CE conformity .....	7
1.4	Technical data, general .....	8
1.4.1	Tank size RM 110 .....	9
1.4.2	Tank size RM 180 .....	10
1.4.3	Tank size RM 210 .....	11
1.5	Warnings and safety precautions .....	12
2	Preparation .....	13
2.1	Scope of delivery .....	13
2.2	Set-up / assembly .....	13
2.3	Start-up .....	14
3	Operation .....	15
3.1	Operating elements .....	15
3.1.1	Ultrasound .....	15
3.1.2	Heating .....	16
3.2	Miscellaneous functions - not applicable - .....	16
3.3	Device signals - not applicable - .....	16
4	Use .....	16
4.1	Instructions for use .....	17
4.2	General use .....	18
4.3	Further information .....	21
4.3.1	Degassing .....	21
4.3.2	Disposal of sonication fluids .....	21

5	Maintenance and cleaning .....	22
5.1	Cleaning and care .....	22
5.2	Warehousing / storage .....	22
6	Maintenance and repair .....	23
6.1	Maintenance .....	23
6.2	Functional checks .....	23
6.3	Error analysis .....	24
6.4	Customer service .....	24
6.4.1	Repairs and service .....	24
6.4.2	Decontamination certificate .....	25
6.4.3	Replacing fuses .....	25
7	Accessories .....	26
7.1	Required accessories .....	26
7.2	Optional accessories .....	27
7.3	Chemical preparations - Recommendations .....	29
8	Consumable materials - not applicable - .....	32
9	Taking the unit out of service .....	32
10	Key words - not applicable - .....	32

## Informative appendices

- A Example of a possible cleaning sequence using peripheral devices
- B Decontamination - sample copy

# 1 Product description

Ultrasonic and rinsing bath, type SONOREX TECHNIK RM ... .

The exact type specification and serial number are found on the type plate, on the rear side of the ultrasonic bath.

## Product features:

- Stainless steel oscillating tank (1) with high-grade PZT high-performance ultrasonic systems, ultrasound frequency 25 or 40 kHz
- Easy-to-clean stainless steel housing (2)
- Filling level mark for safe filling (3)
- Sprinkle tube (4) and weir/overflow (5) with ball valve to produce a liquid circuit.
- Height-adjustable legs (6) for a secure and level position
- Outlet with 3-way ball valve (7) for easy draining/filling of the bath fluid
- Depending on the model, with time switch (type "U") for 1 - 15 min or continuous operation (8) and/or with heating (type "H") (9). The heating elements (10) lie directly in the liquid.

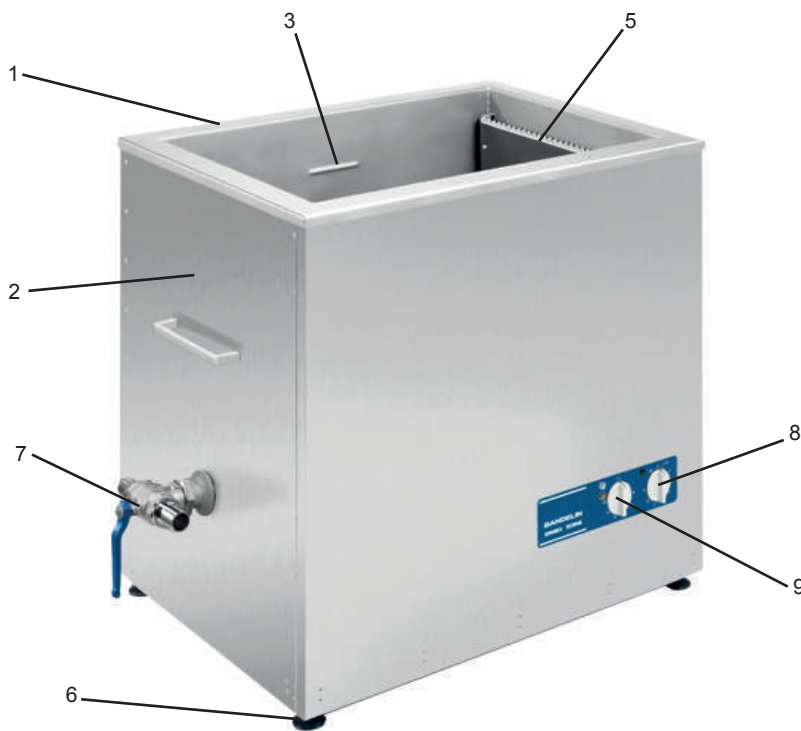

SONOREX TECHNIK RM 110 UH



SONOREX TECHNIK RM 210 UH

## 1.1 Mode of operation

SONOREX ultrasonic baths use the effect of cavitation. Under their oscillating tank bottoms they contain piezoelectric transducers, the energy of which is transferred to the bath liquid with ultrasound frequency as mechanical oscillations. As a result, microscopically small bubbles are continuously formed in the bath liquid, which release energy upon imploding and generate local microcurrents. This process is called cavitation. During the cleaning process, it causes contamination to be "blasted" from the hard surfaces of the objects being treated. At the same time, dirt particles are removed and fresh bath liquid flows in.

During sonochemical processes, cavitation may have a catalytic effect, e.g. with the production of stable emulsions or the rapid degasification of fluids with a high gas content.

## 1.2 Purpose

SONOREX TECHNIK ultrasonic baths are intended for the sonication of aqueous liquids. They work on the basis of low-frequency ultrasound and can be used in versatile ways. Their main application is the gentle and intensive cleaning of objects of diverse shapes, types and sizes.

Sonication is always carried out together with a suitable preparation that is added to the bath fluid. In order to use the device as intended, a basket or other inset beaker is required, into which objects are placed during sonication. An optimum diffusion of the ultrasound can only be guaranteed in this manner.

The unit is operated from the front. SONOREX TECHNIK ultrasonic baths are designed as floor-standing units.

## 1.3 CE conformity

The units fulfill the CE marking criteria of the following European Directives:

- "Low-voltage directive"
- "Electromagnetic compatibility" directive

in their currently valid versions.

A declaration of conformity can be requested from the manufacturer by providing the serial number.

## 1.4 Technical data, general

The ultrasonic and rinsing baths are interference-free and marked with a CE.

Safety: EN 61010-1,

EMC: EN 61326-1

Mains supply: 400 V 3N~ ( $\pm 10\%$ ) 50/60 Hz, cable length 3 m

Frequency: 40 kHz, or 25 kHz upon request

Tanks: Stainless steel, 2 mm, welded, with weir on the right-hand side and sprinkle tube for surface skimming on the left-hand side of the tank

Serial number: see type plate on rear of device

Degree of protection: IP 32 according to DIN EN 60529

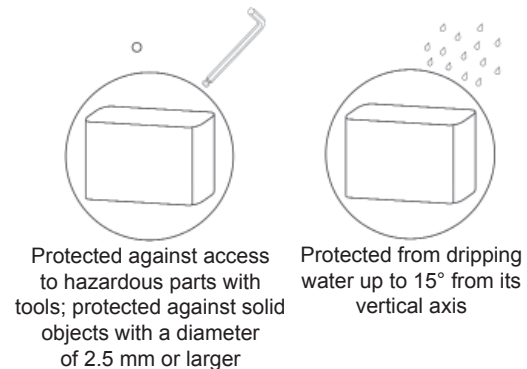

### Environmental conditions pursuant to EN 61 010-1

Overvoltage category: II

Degree of contamination: 1

Permissible ambient temperature: 5 to 40 °C

Permissible relative humidity up to 31 °C: 80 %

Permissible relative humidity up to 40 °C: 50 %

Condensation not allowed.

Only for indoor operation.

### Electromagnetic ambient conditions (EMC)

The device was tested to DIN EN 61326-1 for electromagnetic compatibility (EMC) and complies with the requirements for class B devices according to EN 55011.

It is suitable for use in facilities and areas which are directly connected to a public low-voltage supply network, e.g. medical laboratory facilities.



## 1.4.1 Tank size RM 110

		RM 110 UH	RM 110 H	RM 110 U	RM 110
Exterior dimensions (l × w × h)	mm	780 × 550 × 800			
Interior dimensions (l × w × d)	mm	600 × 450 × 450			
Capacity	l	135			
Filling volume	l	125			
Operating volume	l	110			
Inlet and outlet		G 1 outside			
Sprinkle tube inlet		G ½ inside			
Weir outlet		G 1 outside			
Heating power	W	4800	4800	-	-
Fuses (heating)		T12A	T12A	-	-
Fuses (generator)		T6A	-	T6A	-
Peak ultrasonic output*	W	4000	-	4000	-
Ultrasonic nominal output	W	1000	-	1000	-
Weight (net)	kg	72	60	67	55
Order No. (40 kHz)		8230	-	8231	-
Order No. (25 kHz)		8240	-	8241	-
Order No. (without ultrasound)		-	8232	-	8233

\* In order to improve the effect, the ultrasound is modulated, resulting in the Ultrasonic nominal output value increasing 4-fold as peak ultrasonic power.

## 1.4.2 Tank size RM 180

		RM 180 UH	RM 180 H	RM 180 U	RM 180
Exterior dimensions (l × w × h)	mm	1180 × 600 × 800			
Interior dimensions (l × w × d)	mm	1000 × 500 × 400			
Capacity	l	215			
Filling volume	l	190			
Operating volume	l	160			
Inlet and outlet		G 1 outside			
Sprinkle tube inlet		G ½ inside			
Weir outlet		G 1 outside			
Heating power	W	7200	7200	-	-
Fuses (heating)		T12A	T12A	-	-
Fuses (generator)		T6A	-	T6A	-
Peak ultrasonic output*	W	2 × 4000	-	2 × 4000	-
Ultrasonic nominal output	W	2 × 1000	-	2 × 1000	-
Weight (net)	kg	105	85	98	78
Order No. (40 kHz)		8250	-	8251	-
Order No. (25 kHz)		8260	-	8261	-
Order No. (without ultrasound)		-	8252	-	8253

\* In order to improve the effect, the ultrasound is modulated, resulting in the Ultrasonic nominal output value increasing 4-fold as peak ultrasonic power.

### 1.4.3 Tank size RM 210

		RM 210 UH	RM 210 H	RM 210 U	RM 210
Exterior dimensions (l × w × h)	mm	930 × 750 × 800			
Interior dimensions (l × w × d)	mm	750 × 650 × 500			
Capacity	l	270			
Filling volume	l	245			
Operating volume	l	210			
Inlet and outlet		G 1 outside			
Sprinkle tube inlet		G ½ inside			
Weir outlet		G 1 outside			
Heating power	W	7200	7200	-	-
Fuses (heating)		T12A	T12A	-	-
Fuses (generator)		T6A	-	T6A	-
Peak ultrasonic output*	W	2 × 4000	-	2 × 4000	-
Ultrasonic nominal output	W	2 × 1000	-	2 × 1000	-
Weight (net)	kg	110	90	102	82
Order No. (40 kHz)		8270	-	8271	-
Order No. (25 kHz)		8280	-	8281	-
Order No. (without ultrasound)		-	8272	-	8273

\* In order to improve the effect, the ultrasound is modulated, resulting in the Ultrasonic nominal output value increasing 4-fold as peak ultrasonic power.

# 1.5 Warnings and safety precautions

## General

- Keep the ultrasonic/rinsing bath out of the reach of children and of persons who have not been instructed in its operation by reference to these instructions.
- We do not guarantee against damage to the ultrasonic/rinsing bath or oscillating tank, or to the objects to be treated, as a result of use of inadequate disinfection agents or detergents.
- Keep the surface of the ultrasonic/rinsing bath and operating elements clean and dry.
- Do not expose the ultrasonic/rinsing bath to corroding influences.
- Only move the ultrasonic/rinsing bath when it is empty.
- Empty the ultrasonic/rinsing bath only while turned off.  
The tank is emptied with no peripheral devices connected, using the three-way ball valve. To do so, turn the handle in the direction of the outlet.
- Ultrasonic baths adhere to prescribed EMC limit values, such that it can be assumed that the electromagnetic radiation emanating from the units is harmless to humans. A binding statement for wearers of implants can only be made at the place of work and together with the implant manufacturer. In case of doubt, information regarding the allowable electromagnetic exposure level is to be obtained from the implant manufacturer.
- If the unit is passed on to others, the operating instructions with the safety instructions must also be handed over.

## Operation and transport

- Observe ambient and set-up conditions, see chapter 1.4.
- Only plug in the ultrasonic/rinsing bath to an outlet with a grounded socket.
- Do not operate the ultrasonic/rinsing bath without fluids.
- Do not stand or lay any objects on the tank bottom, accessories must be used, see chapter 7.
- Do not immerse any parts of the body (e.g. hands, feet) or living beings (animals or plants) in the tank; in particular, do not immerse them in the ultrasonic fluid during ultrasound operation. Danger: Ultrasound has a cell-destroying effect.
- In the event of continuous activity within a 5 m radius, adequate hearing protection must be used. Danger: Hearing loss possible if not wearing hearing protection during operation – the typical ultrasound cavitation noise can be perceived as very unpleasant.
- When preheating the bath liquid, stir at least every 30 min. or switch on the ultrasound. Danger: Scalding due to retardation of boiling.
- Do not leave the ultrasonic/rinsing bath unattended while in operation.



## Damages and defects

- If damage to the ultrasonic/rinsing bath is detected, do not connect the ultrasonic/rinsing bath to the mains.
- In the event of defects, disconnect the power plug immediately.
- Repairs must only be conducted by authorised skilled personnel or by the manufacturer.
- Defective parts may only be replaced with original SONOREX parts.

## 2 Preparation

Carefully unpack the ultrasonic/rinsing bath and accessories and inspect them for completeness or possible transportation damages. If any damages or defects are found, these must be immediately notified in writing to the transportation company and to the supplier.

Before startup, the ultrasonic bath is to be left to stand at its operating location for 2 hours so that it may adapt to the ambient conditions.

### 2.1 Scope of delivery

- 1 Ultrasonic/rising bath, see delivery note
- 1 Accessories kit
- 1 Instructions for Use manual

Additional accessories according to order - see delivery note

### 2.2 Set-up / assembly

- Place the ultrasonic/rinsing bath on a firm, level and dry surface. In doing so
  - observe the maximum weight of the tank, including liquids.  
For net weight, see technical data, chapters 1.4.1 to 1.4.3.
  - do not block the air supply below the tank.
  - guard against moisture and wetness - risk of electric shock.
- Operation is not permitted if the legs are not screwed on, this will cause the built-in fan cooling on the bottom of the device to become inoperable.  
Minimum distance to the ground: 30 mm!  
The ultrasonic/rinsing bath will become critically damaged without cooling.



## Set-up

- Fully remove transportation aids (pallets, transport safety devices).
- The height-adjustable legs provided should be mounted on the bottom of the tank. The tank must then be horizontally levelled.
- Set up the ultrasonic/rinsing bath in a dry room.
- Mount the separately-packaged ball valves for each tank as follows:

1. Screw the counter nut onto the threaded sleeves 1 at the tank outlet (3-way ball valve) and tank overflow (ball valve), then seal with the white PTFE tape provided, applying several turns of tape to the right.
  2. Tape the hose socket threads 2 with PTFE sealing tape.
  3. Screw the hose sockets 2 into the ball valve outlets 3, use the appropriate spanner.
  4. Screw the ball valve 3 onto the threaded sleeves and tighten with the counter nut 4.
- Caution:** Do not screw the ball valve up to the limit stop or back it off by rotating it slightly to the left, this will cause the PTFE tape to lose its sealing effect.
5. Close ball valve, turn the lever 5 upwards.

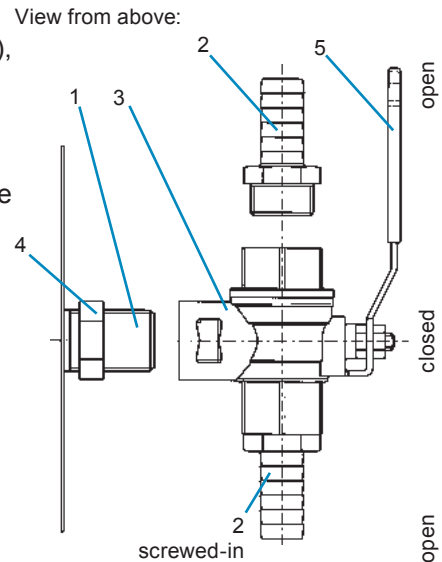

## 2.3 Start-up

- Thoroughly rinse the ultrasonic or rinsing bath's oscillating tank with water before its first use.
- Verify that the control buttons are in the "off" position, i.e. the switch indicator is at the top, then connect the bath to the mains.
- Conduct function test on the ultrasonic bath – briefly plug in the ultrasound (maximum of 1 to 2 seconds), a hissing noise should be heard. Set to "0" once again.
- Hang accessories in the ultrasonic bath and place lid on top.
- Connect peripheral devices if required – see additional documentation.

## 3 Operation

### 3.1 Operating elements

The ultrasound and the heating system are operated from the front:

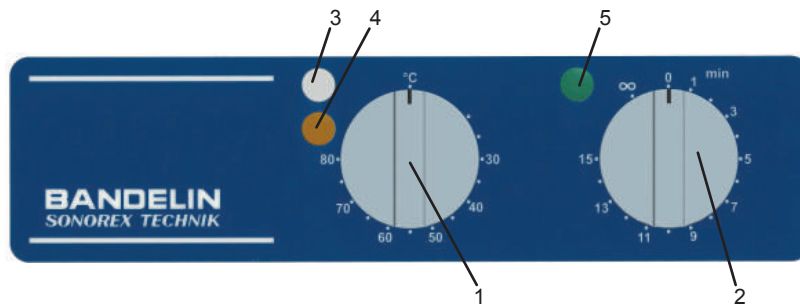

- 1 Turning knob for Heating ON / OFF incl. adjustment control
- 2 Turning knob for Ultrasound ON / OFF with preset time
- 3 White control light (Heating is activated)
- 4 Yellow control light (Heating in operation)
- 5 Green control light (Ultrasound in operation)

The layout of the turning knobs depends on the bath.

#### 3.1.1 Ultrasound

The ultrasound is operated through the turning knob (time switch).

##### Timed operation:

- Turn knob to the right
  - range of time 1 - 15 minutes
    - Green control light is illuminated.
    - Once the time has elapsed, the time switch automatically turns off.
- By turning the knob back, the operating time is shortened or the ultrasonic bath is turned off.

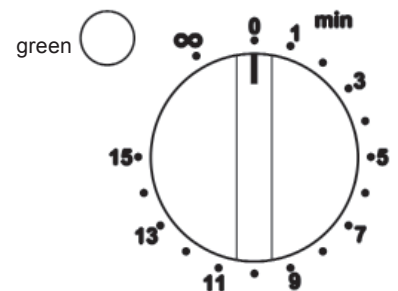

##### Continuous operation:

- Turn knob to the left
  - Setting ∞
    - Green control light is illuminated.
    - The ultrasonic bath does not turn off automatically; to switch it off turn the knob to the right, back to "0".



##### Notes

- Even while turned off, the ultrasonic bath may remain connected to the mains. It can be disconnected by pulling out the mains plug.
- An “engaging” of the time switch is barely felt if mains voltage is not present, e.g. if the mains plug is disconnected or the fuse is blown. The time switch only works if mains voltage is present.

## 3.1.2 Heating

The heating is operated through the turning knob (heating).

- Turn knob to the right
  - Temperature range 30-80 °C:
    - The yellow and white control lights are illuminated.
    - The yellow control light goes out when the set temperature is reached.
    - To turn it off, turn the knob left back to "°C".

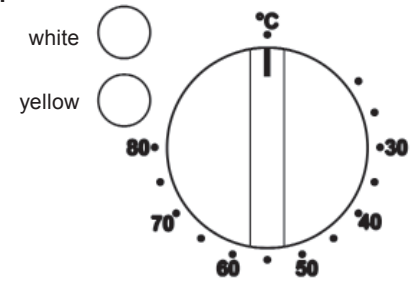

### Notes:

- The heating system works independently from the ultrasound.
- The heating automatically turns on every time that the bath temperature drops below the set temperature.

## 3.2 Miscellaneous functions - not applicable -

## 3.3 Device signals - not applicable -

## 4 Use

Sonication or rinsing always take place directly in the tank. For this purpose, the objects are placed in a basket and hung inside the tank which is filled with bath fluid.

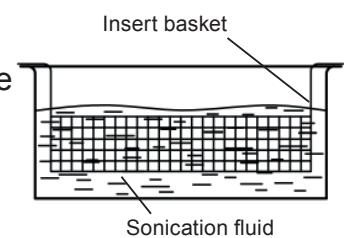



## 4.1 Instructions for use

### Instructions – filling

- Check that all ball valves are closed.
- Ultrasound and heating must be turned off.
- Do not fill ultrasonic tank with hot water. Maximum filling temperature: 50 °C.
- At least drinking-quality water must be used to fill the oscillating tank.
- Water without additives is not suited for sonication. BANDELIN recommends the TICKOPUR or STAMMOPUR preparations.
- The fill level must always be at or slightly above the filling level mark.  
A low fill level will damage the ultrasonic bath!



As a precaution, the ultrasonic bath is equipped with a float switch that protects heaters and ultrasound systems from dry operation. Operation is not possible if the level of liquid in the tank is too low.

When used for extended periods, the device may switch off as a result of evaporation, for example. In such cases, the ultrasound and possibly the heating must be switched off (controller on 0). Once the tank is filled up, the ultrasound and the heating, if applicable, can be switched back on.

- When using with a liquid circuit (with FA, OX, WA or cascade pipes) the additional fill volume of the peripheral devices must be taken into account:  
Fill the ultrasonic bath with water and cleaning concentrate (in the appropriate dose!) up to the weir's toothed edge ⇒ Follow the dosing instructions for the concentrate used. Also fill all additional tanks up to the weir with municipal or DI water.



- Do not use any combustible, explosive, non-aqueous liquids or azeotropic mixtures directly in the stainless steel oscillating tank (e.g. benzine, solvents). Furthermore, chemicals that contain or that separate chloride ions (some disinfectants, household cleaners, and dish detergents), may not be used directly in the stainless steel tank.
- When using strongly acidic preparations, the hard chromium plating of the ball valve may become corroded and the ball valve start to leak.  
If the use of a strongly acidic cleaning agent cannot be avoided, the use of a stainless steel ball valve is recommended.
- When using preparations, the safety instructions included in the product leaflets must strictly be adhered to.
- Replace used sonication fluids, do not refresh by adding fluids.

### Notes - Inserting objects

- Fully remove air bubbles from cavities (e.g. blind holes).

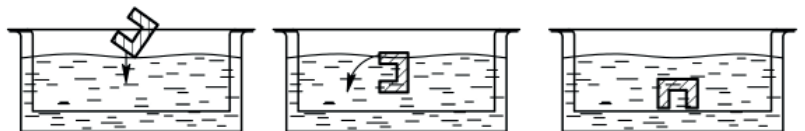

## Notes - Temperature and heating

- Heated fluids intensify the ultrasound effect. Experience has shown that the best results are obtained with a bath temperature of 50 to 60 °C. At higher temperatures, the effect of the ultrasound cavitation decreases again, however<sup>1</sup>.
- In order to save time during use, the bath fluid may be preheated during degassing.
- Ultrasound energy warms up the sonication fluid (even without additional heating).
  - In the case of continuous sonication and/or covering the oscillating tank, the fluid temperature may increase more quickly and even rise above the maximum adjustable value of the thermostat (80°C). For this reason, check the temperature when treating temperature-sensitive components.
  - Non-aqueous fluids can heat up many times faster than water. A possible flashpoint can be reached and/or exceeded after a very short sonication time. In the case of high-boiling liquids (with and without a flashpoint), the bath temperature can increase to >120 °C due to the energy input of the ultrasound. This leads to irreparable damage to the ultrasonic bath.
- For an optimum bath temperature, observe the specifications from the preparation manufacturer!
- To protect the electronic components inside the ultrasonic bath, the ultrasound output is reduced upon reaching a critical temperature in order to inhibit a further increase in the interior temperature.
- The fluid in the oscillating tank may not exceed a maximum operating temperature of 100 °C.
- Cover the ultrasonic bath when in continuous operation so that not too much bath liquid evaporates.
- For safety reasons ultrasonic cleaning baths and rinsing baths should be covered when not in operation, to prevent operating and external personnel from inadvertently coming into contact with the bath liquid or being injured by liquids that are still hot.

## 4.2 General use

### Step 1: Fill oscillating tank

The oscillating tank is filled with water and a suitable preparation to reduce the surface tension, see chapter 7.3.

- Fill 1/3 of oscillating tank with water.
- Add dosed preparation to the oscillating tank.
- Fill carefully up to the filling level mark, avoid the formation of foam as much as possible.

---

<sup>1</sup>/1 MILLNER, R.: Wissenspeicher Ultraschalltechnik, Fachbuchverlag publishing house, Leipzig 1987

## **Step 2: Degassing the fluid**

Freshly-filled bath fluid or fluid that has remained in the oscillating tank for a longer period of time must be degassed prior to use. See also chapter 4.3.1.

- Remove basket and other accessories from the oscillating tank.
- Place lid on top.
- Turn on the ultrasound with the turning knob and sonicate for 30 min for degassing, see chapter 3.1.1.

## **Step 3: Preheat fluid**

In ultrasonic baths with integral heating, the fluid may be preheated independently of the ultrasound. This increases the ultrasound effect, especially when removing fats, oils and polishing paste residue, and shortens the duration of the subsequent ultrasound.

- Remove basket and other accessories from the oscillating tank.
- Place lid on top.
- Using the turning knob, set the desired temperature, see chapter 3.1.2.
- For an even warming of fluids, stir the fluids or switch on the ultrasound for a few minutes now and then, otherwise there will be a retardation of boiling – risk of scalding!

## **Step 4: Insert objects to be treated**

Before every sonication it is necessary to check whether the sonication fluid needs to be cleaned or replaced.

- Hang the insert basket with the items to be sonicated.
- Check that the objects to be treated are fully covered with fluid.
- With every object inserted, the fill level is to be controlled.

## **For cleaning tasks**

Place the objects to be cleaned in the appropriate accessories, in doing so please note:

- Evenly distribute parts, do not stack them.
- Overloading the basket will reduce the ultrasound effect (the ultrasound is absorbed).
- Place the more heavily soiled side facing downward.
- Parts with joints are to be fully opened before placing inside.
- Fragile parts may not touch each other.
- Due to the design, the ultrasound effect is weaker on the outlet side. Heavily contaminated objects should not be placed in the basket over the outlet.

### **Step 5:        Ultrasound - Operation**

Fundamentally, the sonication time is to be as short as possible in order to protect the objects to be treated and the oscillating tank.

In the case of stubborn residue, conduct sonication for a longer time if necessary.

- Place lid on top.
- Using the turning knob, set the desired sonication time, see chapter 3.1.1.

### **Step 6:        Remove treated objects**

After sonication, the objects are to be removed from the ultrasonic bath. Allowing them to remain any longer in the bath fluid may damage them.

- Switch off the ultrasound.
- Remove the basket from the tank and place it securely on a horizontal surface.



Depending upon the set temperature or the duration of sonication, the baskets and objects may be hot!

- After the cleaning processes, rinse the treated objects with water of at least drinking quality. Visually review the sonication results.
- Before the next sonication, verify the service life (see chapter 4.3.2) of the bath fluid. Heed the specifications of the preparation manufacturer. If necessary, empty the oscillating tank.

### **Step 7:        Empty the oscillating tank.**

Layers of contamination on the tank bottom reduce the ultrasonic output.

The oscillating tank is to be emptied after a long period of use or sonication of heavily soiled objects, see chapter 4.3.2.

- Switch off the ultrasound.
- Empty the oscillating tank by pointing the 3-way ball valve handle in the direction of the outlet to open it.
- After emptying the oscillating tank, thoroughly rinse it. Wipe dry with a soft cloth. For additional care instructions, see chapter 5.

## 4.3 Further information

### 4.3.1 Degassing

Degassing the sonication fluid increases the ultrasound effect.

Freshly filled-in fluid or fluid that has remained in the oscillating tank for a longer period of time must be degassed prior to use. Gases dissolved in the fluid (e.g. oxygen) are reduced through degassing and the ultrasound effect is thus significantly improved.

The cavitation noise changes during degassing, loud degassing noises disappear at the end of the degassing process and the ultrasonic bath appears to work more quietly.

A lower noise level, however, does not mean a reduction in ultrasonic power. It rather means the end of the degassing process and an improvement in the ultrasound effect.

### 4.3.2 Disposal of sonication fluids

The working solution should be disposed of pursuant to the specifications of the product leaflet and the label. All aqueous solutions made by DR. H. STAMM GmbH are prepared pursuant to the regulations of the German Washing and Cleansing Agents Act, are biodegradable, and may be discharged into the sewerage as working solutions. Strongly acidic and strongly alkaline fluids are to be previously neutralised pursuant to technical data sheet specifications. The manufacturer specifications for the corresponding preparation should be observed.

During cleaning, materials hazardous to water such as oils, heavy metal compounds, etc., may be introduced to the working solution depending on the type of contamination. If the limit values are exceeded, the working solution must be reconditioned (removal of contaminants) or be disposed of as toxic waste.

Disinfecting and cleaning agents that become contaminated when used are considered "waste material" pursuant to the German Waste Act (AbfG) and may not be taken back by the manufacturer.

In every case, the statutory provisions and regulations of municipal wastewater plants must be adhered to. Information is provided by municipal wastewater plants as well as by environmental agencies.

## 5 Maintenance and cleaning

To achieve an optimum lifespan for the ultrasonic/rinsing bath, cleaning and maintenance should be conducted regularly.



### **CAUTION!**

Disconnect the bath from the mains before each cleaning / maintenance.



Do not rinse or immerse the ultrasonic bath in water and do not expose it to splash water.

No guarantee is given for damages caused by the use of unsuitable disinfection agents or detergents.

### 5.1 Cleaning and care

#### **Oscillating tank**

The oscillating tank of an ultrasonic bath is a wear part.

It is continuously exposed to cavitation during ultrasound operation. Dirt particles remaining in the tank abrade and damage the tank surface due to the movement of the fluid, therefore

- Thoroughly and frequently rinse the oscillating tank with water and wipe dry with a soft cloth.
- Regularly remove residue and scum from the oscillating tank using a commercial stainless steel cleaning product without any abrasive additives.
- Do not use steel wool, scrapers or graters for cleaning / maintenance.
- The free movement and function of the float used for fill level control – on the front, left side – must be checked from time to time.
- Metal particles that remain on the stainless steel surface as well as rust particles from the water pipe system penetrate the passive protective layer of the stainless steel. The stainless steel is "activated" in this process and begins to rust. The extraneous rust produces localised corrosion of the stainless steel. For this reason, remove metal parts such as screws, filings, etc. from the oscillating tank, and immediately remove rust stains using a soft cloth and a commercial stainless steel cleaning product without abrasive additives.

#### **Housing**

- Do not use any abrasive cleaners, only commercial care products without abrasive additives.
- The exterior of the housing should be wiped down with a damp cloth and left to dry, or wiped dry.

### 5.2 Warehousing / storage

During long periods of non-use, the ultrasonic/rinsing bath must be stored in a cool, dry location. The lid should be placed on top in order to protect the bath from outside contamination.

# 6 Maintenance and repair

## 6.1 Maintenance

SONOREX TECHNIK ultrasonic/rinsing baths are maintenance-free.

For purposes of regular inspection, the following functional checks may be carried out.

## 6.2 Functional checks

### Checking control lights

- Pursuant to chapters 3.1.1 and 3.1.2.

### Checking the ultrasound and/or heating

The function can be checked using a standard wattmeter. It should be inserted between the ultrasonic bath's mains plug and the socket.

- Fill the tank with fluid, see chapter 4.2.
- For testing purposes, only the ultrasound or only the heating system should be plugged in. Next, the value displayed is to be compared with the corresponding value in the technical data (chapter 1.4) (tolerances  $\pm 20\%$ ).

### Checking the ultrasound effect

- For this check, it is recommended that a foil test be conducted (semi-annually). Ordinary aluminium foil is used to conduct the test. Next, a comparison is made with previously-generated foils, if applicable.  
Detailed information available upon request.

### Check the float switch

The float switch is situated directly in the tank and is therefore a wear part.

The function and tightness of the float switch must be checked at regular intervals.

- If the tank is already full, the float must rise to the upper limit stop (upper ring).
- In an empty tank, the rising ability of the float can be easily tested using a beaker filled with water, or similar. To do so, raise the beaker from below over the float - it must rise upwards.
- If the float or float switch are defective, they must be replaced since the safety of the bath is no longer guaranteed (order No.: 3112 - black float; 3111 - white float; 3105 - float switch complete).

## 6.3 Error analysis

SONOREX ultrasonic and rinsing baths are robustly constructed and designed for a high level of reliability.

Nevertheless, the possibility of a malfunction due to a defective component can never be fully discounted.

The following overview of possible sources of error should serve as an aid for error detection and elimination.

- Ultrasonic bath oscillates weakly, unevenly, or noise is too loud:
  - Has fluid been properly degassed? ⇒ Treat for 30 min.
  - Is it overloaded with objects to be treated? ⇒ Remove a few parts.
  - Uneven noises (wobbling) ⇒ No error - slightly adjust the fill level of the fluid.
- Heating system defective?  
The ultrasonic bath can be readily operated without heating.
- Slight erosion visible on the bottom of the bath? ⇒ Natural wear.  
Ultrasonic bath OK.  
Strong erosion marks appear at the tank bottom  
→ lead to loss of power

Any malfunctions must be communicated in writing to the manufacturer.

## 6.4 Customer service

If service is required, please contact your specialist dealer or Bandelin electronic to order spare parts or before sending in defective devices.

### 6.4.1 Repairs and service

If errors or defects are ascertained as a result of the functional check, and if it is impossible to rectify such errors, the ultrasonic bath may no longer be used. In such a case, please contact the supplier or the manufacturer:

BANDELIN electronic GmbH & Co. KG  
Heinrichstrasse 3-4  
12207 Berlin

Repair service:  
Phone: +49-(0)-30 – 768 80 – 13  
Fax: +49-(0)-30 – 76 88 02 00 13

E-mail:  
[info@bandelin.com](mailto:info@bandelin.com)



In the case of returns, the general terms and conditions for delivery and payment of BANDELIN electronic GmbH & Co. KG shall apply.  
In addition, the ultrasonic bath must be cleaned and decontaminated (if necessary), see the upcoming chapter.

## 6.4.2 Decontamination certificate

If the ultrasonic/rinsing bath is sent back to the manufacturer for repairs (with accessories, if applicable), the form "Certificate of Decontamination" must be filled out and affixed to the packaging on the outside, in a visible spot.  
If this form has not been filled out, we reserve the right to refuse receipt of the package in order to protect our employees.

The form can be downloaded from the Internet as a PDF file:  
[www.bandelin.com](http://www.bandelin.com) - Downloads ...  
A sample copy can be found in the appendix.

## 6.4.3 Replacing fuses

### CAUTION!



Repair work may only be carried out by authorised, qualified personnel or by the manufacturer. The manufacturer assumes no liability for unauthorised work performed on the ultrasonic bath!



The mains plug must be pulled out before opening the ultrasonic bath!  
There is a risk of electric shock from live parts in the ultrasonic bath!

- Empty the ultrasonic/rinsing bath and disconnect from the mains.
- Carefully place it on its back side. Be careful not to bend the mains cable. We recommend that a pair of suitable wooden slats be placed under the tank while the replacement process is taking place.
- Unscrew the base plate, loosen it and open it.
- Unscrew and remove the cover.
- The fuses are situated in the fuse switch disconnectors and on the power modules.
- After inspection, replace only the defective fuses. The fuse values are listed under "Technical Data".
- Reassemble the ultrasonic bath following the reverse order.
- Turn the bath upright and reconnect the mains plug.
- The ultrasonic/rinsing bath is once again ready for operation.

# 7 Accessories

The proper accessories facilitate use of the ultrasound and also protect the oscillating tank and objects to be treated.

BANDELIN offers a broad range of accessories, see appendix.

Additional information may be obtained from our supplier, our sales representatives, or from our website.

No-obligation telephone consultation:  
+49-(0)-30 – 768 80 – 0

Website:  
[www.bandelin.com](http://www.bandelin.com)

## 7.1 Required accessories

The baskets and basket holder, for example, are required accessories.

Do not stand or lay any objects directly on the tank bottom.

Accessories	Series RM 110		Series RM 180		Series RM 210	
	Type	Order No.	Type	Order No.	Type	Order No.
Stainless steel insert basket, bearing capacity up to 20 kg	MK 110	8423	MK 180	8424	MK 210	8425
	MK 110 B*	8417	MK 180 B*	8418	MK 210 B*	8419
Stainless steel basket, bearing capacity up to 40 kg	MK 110 S	8476	MK 180 S	8477	MK 210 S	8478
	MK 110 BS*	8481	MK 180 BS*	8482	MK 210 BS*	8483
Stainless steel lid	MD 110	8446	MD 180	8447	MD 210	8448

\* Baskets for lifting device.



## 7.2 Optional accessories

Optional accessories are drop plates, lifting devices, etc.

Accessories	Series RM 110		Series RM 180		Series RM 210	
	Type	Order No.	Type	Order No.	Type	Order No.
Drop plate between 2 tanks	TB 110	8403	TB 180	8404	TB 210	8405
Lifting device with oscillation	MB 110	8310	MB 180	8311	MB 210	8312
Lifting device with oscillation for WG	MB 110 B	8314	MB 180 B	8315	MB 210 B	8316
Tank rack for 2 tanks	WG 110-2	8520	WG 180-2	8523	WG 210-2	8526
Tank rack for 3 tanks	WG 110-3	8521	WG 180-3	8524	WG 210-3	8527
Tank rack for 4 tanks	WG 110-4	8522	WG 180-4	8525	WG 210-4	8528
Filtration with prefilter and main filter, including connection set	FA 110	8611	FA 180	8612	FA 210	8613
Oil separator incl. connection set	OX 110	8603	OX 180	8604	OX 210	8605
DI water treatment device incl. connection set	WA 110	8635	WA 180	8636	WA 210	8637
Cascade pipes between 2 rinsing tanks	KV 112	8456	KV 182	8457	KV 212	8458
Trough dryer	TO 110	8337	TO 180	8338	TO 210	8339

Detailed specifications can be found in the Operating Instructions for the respective device.

### Lifting device with oscillation MB

The electrically-driven lifting device with oscillation facilitates the lifting and lowering of the goods basket. The cleaning efficiency is increased and loosened dirt particles are rinsed off.



### Tank rack WG

Tank racks for positioning the lifting device are designed for 2 to 4 tanks.



### Filtration FA

Thanks to continuous filtering of the loosened particles, the lifetime of the tank is increased and the cleaning power is preserved.



### Oil separator OX

To be connected to the ultrasonic cleaning tank when cleaning very oily or greasy parts. Impurities that rise to the surface of the tank are led via the weir into the oil separator, where they are separated by gravity.



### DI water treatment device WA

To be connected to a rinsing tank. Used to eliminate any water residue that could leave spots on the treated objects during the drying process.



### Trough dryer TO

The treated objects are dried after rinsing, to quickly remove any residual moisture.



## 7.3 Chemical preparations - Recommendations

Ultrasound applications require special preparations that are suitable for use with ultrasound, i.e. cavitation-conducive, biodegradable, easily disposable, gentle to the material and long-lasting.

BANDELIN recommends the TICKOPUR or STAMMOPUR concentrates by DR. H. STAMM GmbH, which have been especially developed for ultrasound use and which utilise the ultrasound optimally.

Additional information may be obtained from our supplier, our sales representatives, or from our website.

No-obligation telephone consultation:

+49-(0)-30 – 768 80 – 280

Website:

[www.dr-stamm.de](http://www.dr-stamm.de)



### IMPORTANT!

- When using preparations, the safety instructions on the label and in the respective product leaflet must be strictly adhered to.
- Keep the preparations out of the reach of children and also of persons who have not been instructed in their use by reference to the product information.
- Do not ingest or inhale the preparations, and do not allow them to come into contact with the eyes or skin.
- Specimens in powder form may only be used in fully-dissolved form.

Depending on the cleaning task, the best cleaning results can be achieved when using the following TICKOPUR preparations.

Contamination	Objects to be cleaned	Cleaning concentrate	Litres	Order No.
<b>Universal cleaner</b>				
General contamination, drilling, grinding, polishing and lapping residue, oil- and grease-based residue, soot, ink, etc.	Metal, glass, ceramics, plastic, rubber, windows, goggles, E-filters, respiratory masks (EXAM certificate No.: 5734/06) etc. <b>Caution</b> with tin and zinc.	<b>TICKOPUR R 33</b> Universal cleaner with corrosion protection for Service, Industry, Technology and Laboratories, gentle to material, mildly alkaline, pH 9.9 (1%) application 1-5 %	2 l	883
			5 l	831
			25 l	835
			200 l	837
<b>Neutral cleaner, gentle</b>				
Light drilling, grinding, polishing and lapping residue, dust, soot, oil and grease contaminants, etc.	Metal, glass, ceramics, plastics, rubber, etc.	<b>TICKOPUR R 30</b> Neutral cleaner with corrosion protection, gentle to material, neutral, pH 7 application 1-5 %	2 l	879
			5 l	811
			25 l	812
			200 l	814
<b>Special acid-based cleaner</b>				
Mineral residue, flash rust, grease, oils, waxes, pigments; drilling, grinding, polishing and lapping residue, etc.	Metal, glass, ceramics, plastics, rubber, etc.	<b>TICKOPUR TR 3</b> Special cleaner based on citric acid, gentle to the material, phosphate-free, with corrosion protection, mildly acid, pH 3.0 (1 %) application 5 %	2 l	923
			5 l	935
			25 l	937
			200 l	973

Contamination	Objects to be cleaned	Cleaning concentrate	Litres	Order No.
Heavy mineral residue (limescale, silicates, phosphates, cements, etc.), rust, temper colors, metal oxides, grease and oil films, etc.	Steel, stainless steel, precious metals, glass, ceramics, plastic, rubber.  <b>Not</b> for light or non-ferrous metals, tin, zinc.	<b>TICKOPUR R 27</b> Special cleaner based on phosphoric acid, for decalcification and rust removal, with corrosion protection, acidic, pH 1.9 (1 %) application 5 %	2 l	874
			5 l	816
			25 l	817
			200 l	826
<b>Special acid-based cleaner, demulsifying</b>				
Mineral residue, flash rust, grease, oils, waxes, pigments; drilling, grinding, polishing and lapping residue, etc.	Metal, glass, ceramics, plastics, rubber, etc.	<b>TICKOPUR TR 2</b> Special demulsifying cleaner based on phosphoric acid, gentle to the material, with corrosion protection, mildly acidic, pH 3.6 (1 %) application 0.1 - 5 %	2 l	866
			5 l	893
			25 l	895
			200 l	851
<b>Special alkaline cleaner</b>				
Resinous flux, soldering pastes, ionic and non-ionic residue; drilling, grinding, polishing and lapping residue, fingerprints, grease, oils, etc.	Non-ferrous and light metals, steel, stainless steel, glass, ceramics, plastics, rubber, assembled and unassembled PC boards, soldered frames, electronic components, modular components, etc.	<b>TICKOPUR TR 14</b> Flux remover, tenside-free, non-foaming, gentle to the material, phosphate-free, alkaline, pH 10.7 (1 %) application 10 %	2 l	873
			5 l	861
			25 l	862
			200 l	864
Distillation residue, organic and inorganic residues, oil and grease contaminants, etc.	Metals including burnished metals, glass, ceramics, plastics, rubber, etc.  Especially for galvanic, laser and analytical applications.  Dilute with DI water.	<b>TICKOPUR R 32</b> Special cleaner, free of complexing agents, gentle to the material, with corrosion protection, mildly alkaline, pH 11.1 (1 % in DI water) application 0.25 - 5 %	2 l	882
			5 l	832
			25 l	834
			200 l	842
General soiling, oils, greases, distillation residue, organic and inorganic residues.	Steel, light and precious metals, ceramics, plastics, rubber, glass, optical glass, vertical and horizontal blinds.  <b>Caution</b> with tin and zinc.	<b>TICKOPUR R 36</b> Special cleaner, tenside-free, for analytical and technical laser applications, for the cleaning of blinds, gentle to the material, non-foaming, mildly alkaline, pH 9.9 (1%) application 0.25 - 5 %	2 l	884
			5 l	854
			25 l	856
			200 l	858
<b>Special alkaline cleaner, demulsifying</b>				
Oils, greases, waxes, pigments, flux, soldering pastes, drilling, grinding, polishing and lapping residue.	Steel, stainless steel, non-ferrous, precious and light metals, glass, ceramics, plastics, rubber, soldered frames.	<b>TICKOPUR TR 7</b> Universal cleaner, demulsifying, for fast separation of oil and grease, mildly alkaline, pH 8.9 (1 %) application 0.1 - 5 %	2 l	867
			5 l	838
			25 l	840
			200 l	839
Gumming, coking residue, soot, oils, grease, waxes, pigments, coatings; drilling, grinding, polishing and lapping residues, etc.	Steel, stainless steel, glass, ceramics, plastics, rubber. Not for light alloys, tin, zinc. Non-ferrous heavy metals may become corroded.	<b>TICKOPUR TR 13</b> Intensive cleaner, demulsifying against stubborn residue, free of phosphates and silicates, alkaline, pH 11.9 (1 %) application 0.1-10 %	2 l	872
			5 l	848
			25 l	850
			200 l	853

Contamination	Objects to be cleaned	Cleaning concentrate	Litres	Order No.
<b>Alkaline cleaner for heavy soiling</b>				
Gumming, soot, fats, oils, waxes, pigments, coatings, silicone oils, flux, oxide on non-ferrous and precious metals.	Non-ferrous and precious metals, iron, steel, glass, ceramics, plastics, rubber, test sieves, circuit boards for service. <b>Caution</b> with light metals.	<b>TICKOPUR RW 77</b> Special cleaner with ammonia, phosphate-free, mildly alkaline, pH 9.9 (1 %) application 5 %	2 l 5 l 25 l 200 l	898 871 875 868
Coking residue, gumming, soot, pigments, greases, oils, waxes, silicone oil, coatings; drilling, grinding, polishing and lapping residues, etc.	Steel, stainless steel, glass, ceramics, plastics, rubber. <b>Not</b> for light metals, tin, zinc.	<b>TICKOPUR R 60</b> Intensive cleaner, phosphate-free, strongly alkaline, pH 12.8 (1 %) application 2 - 20 %	2 l 5 l 25 l 200 l	896 818 819 845

All TICKOPUR preparations may also be used with submersion and wiping procedures.

### Corrosion protection for ferrous metals

Materials	Properties	Concentrate	Litres	Order No.
Suitable for all ferrous metals such as cast irons, unprotected steels of diverse alloys.	Effective corrosion protection for use after cleaning with TICKOPUR agents, and subsequent rinsing with water. No formation of oily or greasy films.	<b>TICKOPUR KS 1</b> Universal corrosion protection for all ferrous metals, free of solvents, neutral, pH 7.4 (1%) application 0.5 - 2 %	2 l 5 l	6011 6012

## 8 Consumable materials - not applicable -

## 9 Taking the unit out of service

If the ultrasound/rinsing bath no longer works, it must be appropriately disposed of. Some electrical components are considered to be toxic waste.



## 10 Key words - not applicable -



# A Example of a possible cleaning sequence using peripheral devices

The SONOREX TECHNIK Modular Program can be assembled individually. It is comprised of efficient ultrasonic baths and rinsing tanks in different sizes with and without heating, as well as a large variety of additional equipment to facilitate work, extend the lifetime of the tanks, and dry the cleaned parts.

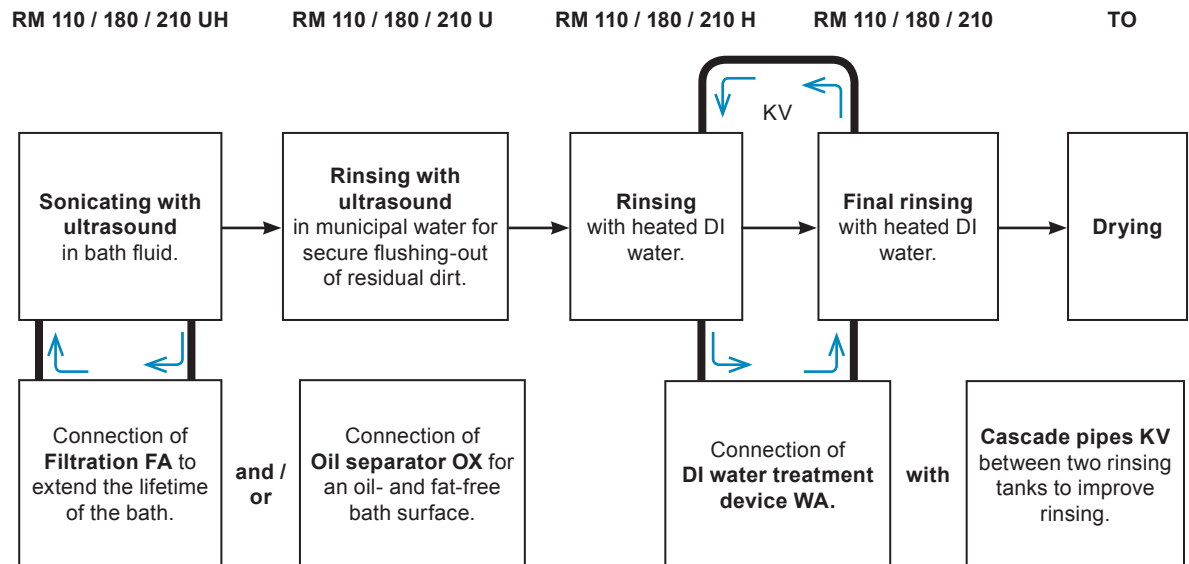

Filtration and oil separators can be jointly operated in the ultrasonic baths. In such a case, the filtration is provided with a backflow pipe that can be hung over the tank edge.

The electric lifting device with oscillation MB enables the lifting and lowering of the basket and provides an up and down motion in the bath during the cleaning process, improving the cleaning effect.

The modular system allows for individual assembly of these items depending on the cleaning task. A significant advantage is that the system can be expanded at any time.

## B Decontamination - sample copy

### Certificate of Decontamination

**!!! CAUTION !!!**

***This form must be visibly affixed to the outside of the package!***

This "Certificate of Decontamination" is intended to protect the occupational health and safety of our employees pursuant to the German Protection against Infection Act and trade association accident prevention regulations.

Please understand that we can only initiate work operations when this Certificate is submitted.

Before sending the unit back to us for inspection/repair, the unit and accessories must be cleaned pursuant to current laws and regulations and, if necessary, must also be disinfected with a surface disinfection agent listed by the VAH.

Device type: \_\_\_\_\_

Serial number: \_\_\_\_\_

Accessories \_\_\_\_\_

Device / accessories ...	
are not contaminated:	<input type="checkbox"/>
were cleaned before shipping?	<input type="checkbox"/>
are free of toxic matter?	<input type="checkbox"/>
have been decontaminated and/or disinfected and no longer pose a health risk?	<input type="checkbox"/>

With what type of toxic materials have the device / accessories been in contact with?

Corrosive

Biologically hazardous (e.g. microorganisms)

Toxic

Radioactive

None

## Certificate of Decontamination

**!!! CAUTION !!!**

***This form must be visibly affixed to the outside of the package!***

### **Legally binding statement**

I/We hereby declare that the device and accessories found in this package have been cleaned and/or disinfected pursuant to current laws and regulations and that the information provided in this declaration is correct and complete:

Company /  
Institute:

\_\_\_\_\_

Street and  
number:

\_\_\_\_\_

Postal code, city:

\_\_\_\_\_

Department:

\_\_\_\_\_

Name:

\_\_\_\_\_

Telephone,  
extension:

\_\_\_\_\_

Fax:

\_\_\_\_\_

### **Reason for return:**

\_\_\_\_\_

Thank you,  
in this way  
you help us to  
reduce costs.

\_\_\_\_\_

\_\_\_\_\_

\_\_\_\_\_

\_\_\_\_\_ Date

\_\_\_\_\_ Signature

\_\_\_\_\_ Company stamp

**Note:**

The Instructions for Use in this and other languages, as well as further information, can be found on the enclosed CD.